

THANK YOU FOR BUYING PLAYWOOD.  
ENJOY YOUR ASSEMBLY KIT AND  
START NEW PROJECTS.

感謝您購買P木釘  
享受組裝樂趣,開始新創作!



總代理 | 台灣中崙經貿

+886 3 4906580 www.vork.com.tw info@vork.com.tw



x4



x4



x4



x4



x1

EN PLAYWOODIT'S COMPONENTS, ALLEN KEY, SCREW & NUTS INCLUDED.

CN 包裝內含P木釘構件、六角扳手、螺絲及螺帽



EN WE SUGGEST YOU TO USE WOOD FROM SUSTAINABLE FORESTS.

CN 誠摯建議您使用永續木材

WE CAN INSPIRE YOU  
**FOLLOW THE INSTRUCTIONS  
OR VISIT OUR WEBSITE  
TO TRY NEW DESIGNS**

激發您的靈感！  
請按照使用說明書或是拜訪  
我們的網站來嘗試新設計

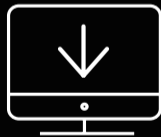

EN PLEASE VISIT OUR WEBSITE [WWW.VORK.COM.TW](http://WWW.VORK.COM.TW)

CN 請拜訪我們的網站找尋靈感

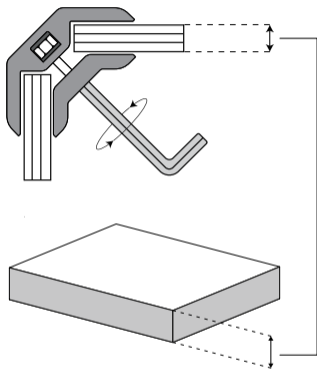

板材厚度  
**PANEL THICKNESS**  
 16~19 mm

**SOLID WOOD**  
 實木

**PLYWOOD**  
 膠合板

**LAMINATED WOOD**  
 美耐板

**(Valchromat) MDF**  
 (沃克板) 密底板

**OSB**  
 纖維板

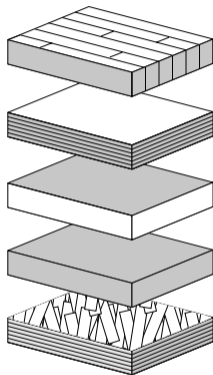

\$\$\$



板材  
 種類&價位

**PANEL TYPE & COST**

\$

EN PANELS THICKNESS MUST BE UNIFORM AND BETWEEN 16-19MM.



CN 板材厚度必須一致，位在16至19公釐之間

x1  105°  
x1  150°

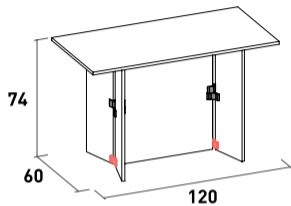
 15 min



1

x1  105°  
x1  150°

 15 min

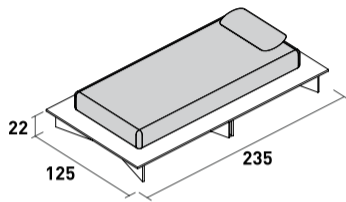

2

measure in cm | 單位: 公分

### PANELS

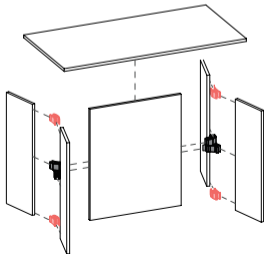
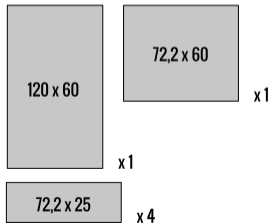

### PANELS

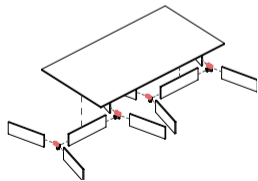
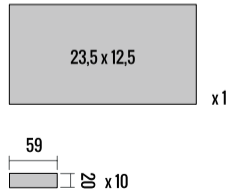

x3  90°  15 min

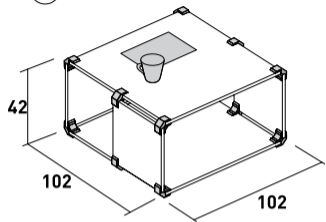

3

x3  90°  15 min

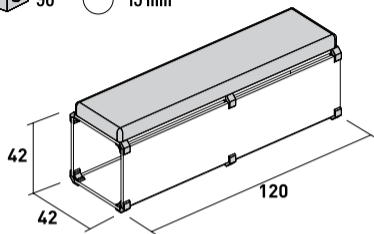

4

measure in cm | 單位: 公分

### PANELS



x2



x2



x1

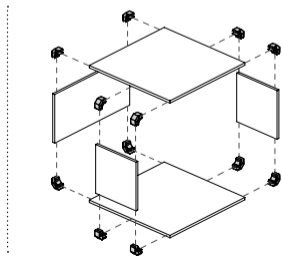

### PANELS



x4

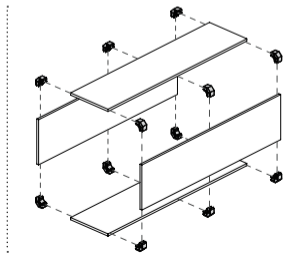

x 4  90°  15 min

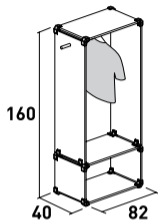

5

x 1  90°  5 min

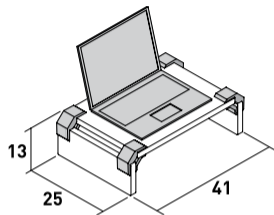

6

measure in cm | 單位: 公分

### PANELS

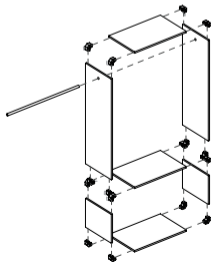
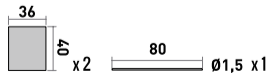

### PANELS

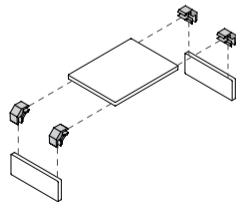
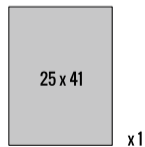
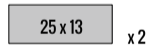

x2  105°  10 min

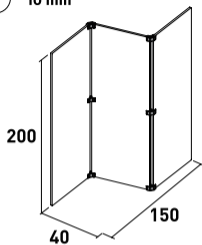

7

x3  90°  15 min

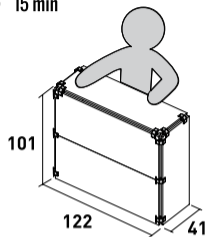

8

measure in cm | 單位: 公分

PANELS

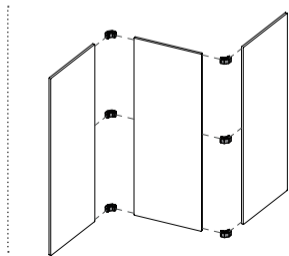

PANELS

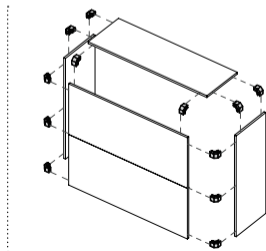
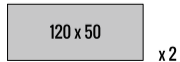

x6  90°  30 min

9

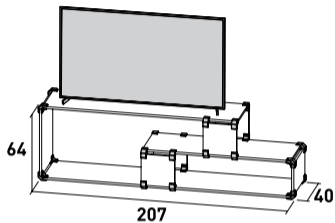

x2  105°  10 min

10

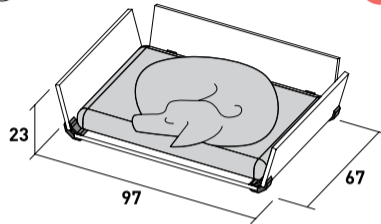

measure in cm | 單位: 公分

### PANELS

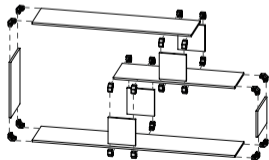
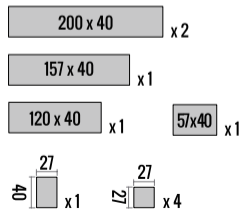

### PANELS

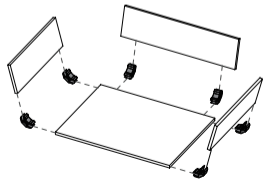
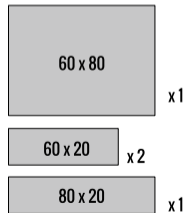



x2  90°  15 min

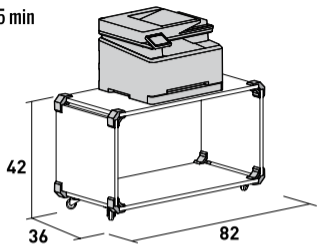

11

x4  90°  20 min

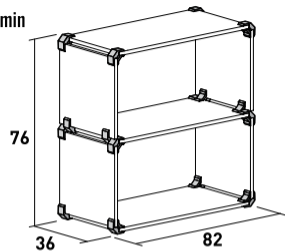

12

measure in cm | 單位: 公分

### PANELS

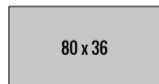

x2



x2

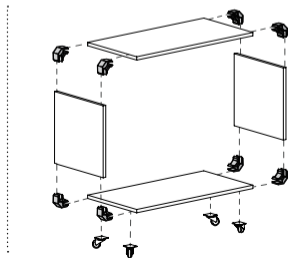

### PANELS

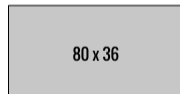

x3

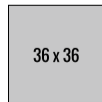

x4

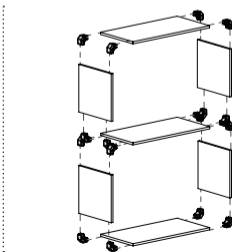

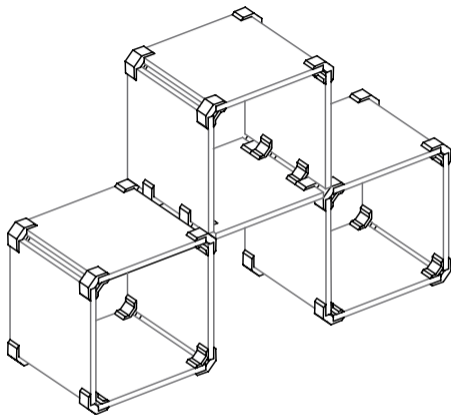
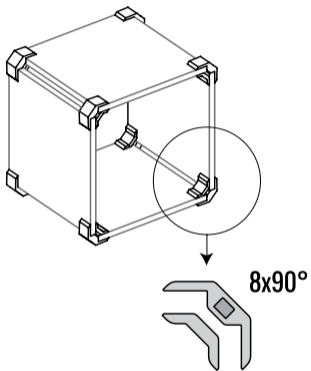
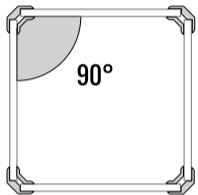

**SQUARE-SHAPED STRUCTURE**

四邊型架構

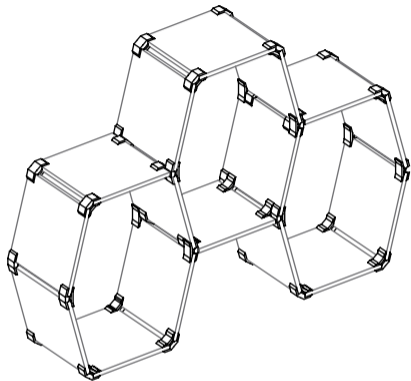
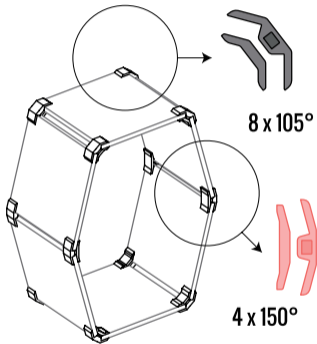
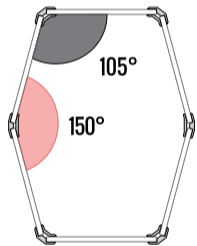

**HEXAGONAL-SHAPED STRUCTURE**

六邊型架構



## HOW TO COMBINE THE CONNECTORS

如何結合P木釘

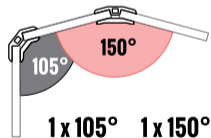
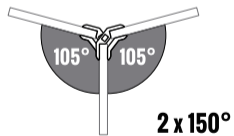
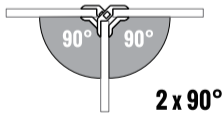
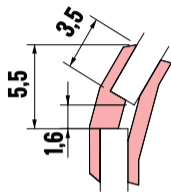
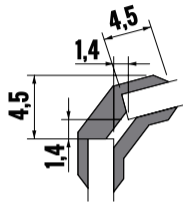
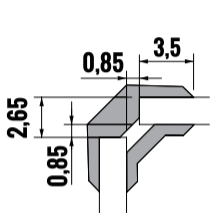



## LOAD CAPACITY

承載重量

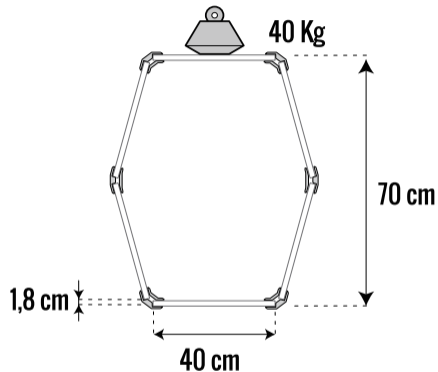
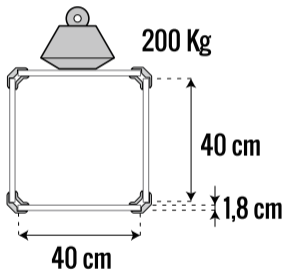

EN THE STRUCTURES RESISTANCE DEPENDS ON THE MATERIAL USED AND THEIR SHAPE.

CN 抗結構性能取決於所用材料及其形狀

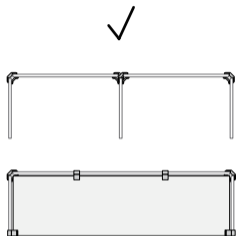
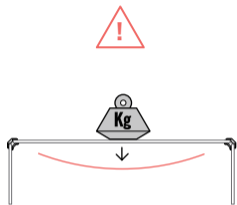
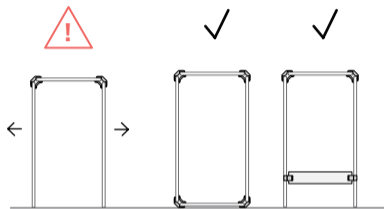

## HOW TO BUILD SAFE STRUCTURES

### 如何建立安全結構

EN OPEN STRUCTURES HIGHER THAN 50 CM CAN BE UNSTABLE. TOO LONG PLANKS CAN BEND.

CN 開放結構高於50公分可能會不穩定－太長的板材會彎曲

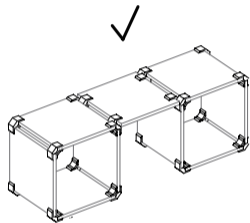
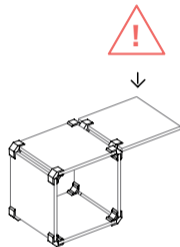
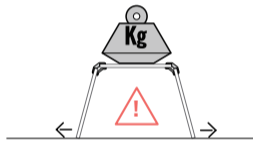
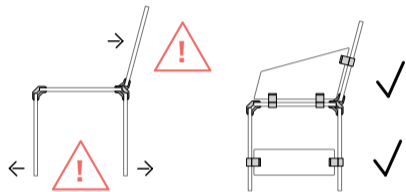

EN MIND THE LEVERAGES: THE STRUCTURE CAN COLLAPSE, OPEN STRUCTURES ARE OFTEN NOT RESISTANT ENOUGH.

CN 留意支點：結構可能塌陷，開放結構不夠穩固



MAKE YOUR OWN FURNITURE  
**NOW IS YOUR CHANCE**  
製作專屬您的傢俱就趁現在

TO PARTICIPATE, USE THE HASHTAG  
加入我們，使用主題標籤  
**#P木釘**



P木釘



### **PLAYWOOD**

IS A PRODUCT OF SPACE MATTERS S.R.L.  
VIA ELBA, 11 - 42124 REGGIO EMILIA, ITALY  
MARKS AND DESIGN REGISTERED  
INFO@PLAYWOOD.IT



台灣總代理  
中崧經貿有限公司  
www.vork.com.tw | facebook.com/vorktaiwan  
info@vork.com.tw | +886 3 4906580